



55 Watt

AS55M6-36

166mm 36Cells PV Module

Electrical Characteristics

Module Type	AS55M6-36
	STC
Maximum Power- Pmax(W)	55
Open Circuit Voltage - Voc(V)	23.79
Short- Circuit Current - Isc(A)	2.82
Voltage at Pmax -Vmp(V)	20.54
Current at Pmax - Imp(A)	2.68
Module Efficiency -ηm(%)	17.87
Power Tolerance(W)	0 ~ +3%
Maximum System Voltage(V)	1000Vdc (IEC / UL)
Maximum Series Fuse Rating (A)	10A

STC : Irradiance 1000W/m², Cell Temperature 25°C, AM 1.5

Mechanical Specifications

External Dimensions	570*540*25mm
Weight	3.3kg
Solar Cells	Mono crystalline 166X41.5mm (3X12pcs)
Front Glass	3.2 mm tempered glass
Frame	Aluminum
Junction Box	IP67
Output Cables	Without cables and connector
Mechanical Load	Front Side Max. 5400Pa, Rear Side Max. 2400Pa

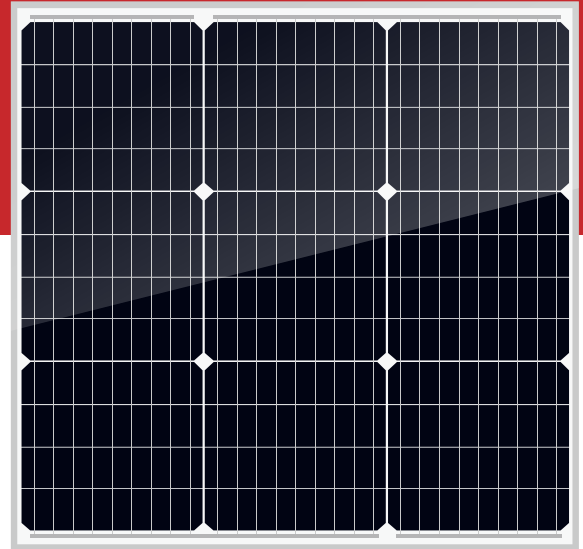

Temperature Characteristics

Pmax Temperature Coefficient	-0.400%/C
Voc Temperature Coefficient	-0.330%/C
Isc Temperature Coefficient	+0.048%/C
Operating Temperature	-40~+85 C
Nominal Operating Cell Temperature(NOCT)	45±2 C

Packing Configuration

Module Type	AS55M6-36
Module Dimensions	570*540*25mm
20FT	10Package/2520PCS
40HQ	20Package/6400PCS

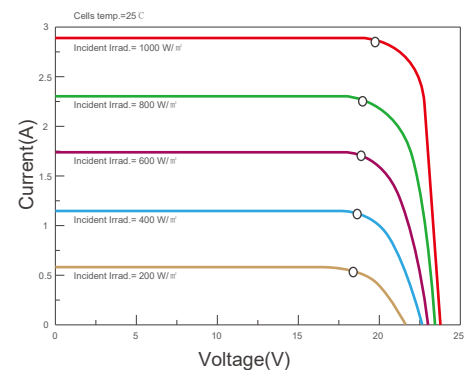
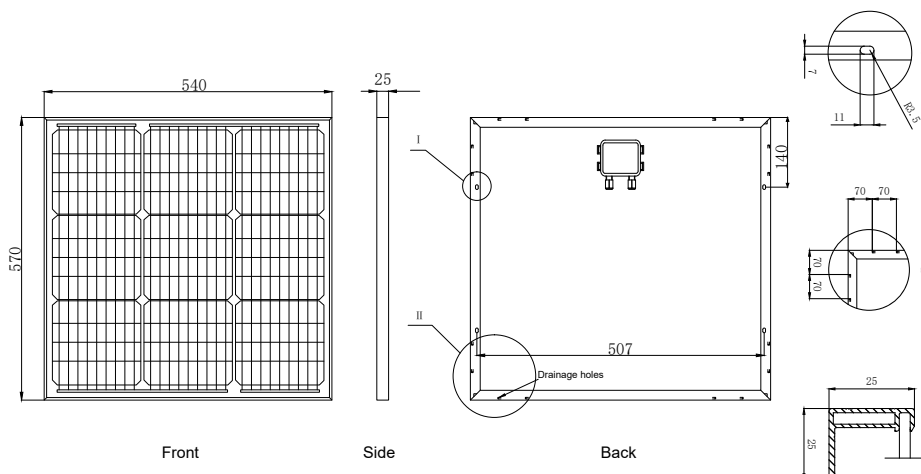

Specs are subject to change without further notification